

# Xacti

## Multispectral gimbal camera CX-GB300

---

### User Manual

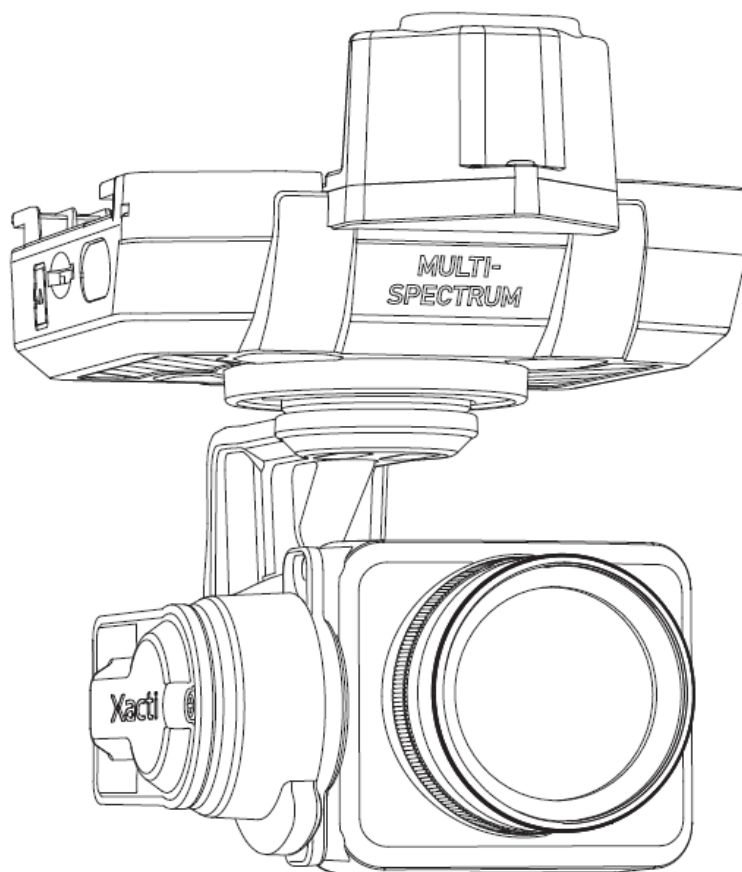



## Contents

1. Safety Cautions.....	2
2. Notice/Cautions for use.....	4
3. Troubleshooting .....	5
4. Camera and accessories .....	5
5. Diagram.....	6
6. Installing/Removing the cap.....	7
7. Installing/Removing the triple bandpass filter .....	8
8. Inserting a microSD card .....	8
9. Specifications .....	9
10. System specification .....	10
11. Software information about the camera.....	10



## 1. Safety Cautions





This section explains safety precautions users must observe to prevent personal injury and property damage.







The following is a classification and explanation of the degree of harm or damage that may result from misuse.





 Warning	If this warning is ignored and the camera is mishandled, death or serious injury may result.
 Caution	Improper use of the camera and disregarding this warning may result in minor personal injury and/or property damage.





The following legends explain the safety precautions users must observe. (The following defines each symbol as used in the legends.)

	follow directions		prohibition
--	-------------------	--	-------------

 Warning	
	<p>Stop using immediately in case of abnormality or malfunction.          Unplug the power supply/communication connector in case of any abnormality.          (e.g., smoke, abnormal smells or noises, water or foreign objects got inside the camera, camera got damaged.)          Using the camera in this condition may cause fire or electric shock. Unplug the power supply/communication connector immediately and consult your dealer.</p>
	<p>Check the temperature of the camera before working on it.          There is a risk of burns due to high temperatures if the camera is left in a high-temperature environment (for instance, if the camera is exposed to direct sunlight for a long period of time) or used continuously.</p>
	<p>Attach this camera correctly.          If the camera comes off or falls off of the drone during use, it may cause damages and/or injuries.</p>
	<p>Do not do anything to damage the camera/cap.          (e.g., damaging, processing, placing near a heat source, forcibly bending, twisting, pulling, placing a heavy object on the camera/cap, etc.)</p>

	Using damaged camera/cap may cause electric shock or fire due to short circuit.
	Do not put foreign objects inside or pour water or other liquids on the camera or any of its ports or allow it to get wet in any way. Doing so may cause a short circuit or overheating, resulting in fire, electric shock, or malfunction.
	Do not use in the presence of flammable, explosive, or inflammable substances. Do not use in places where dust is prevalent and/or generated. Doing so may cause fire and/or explosion.
	Do not directly touch this camera while it has been energized for a long period of time. Prolonged direct skin contact with hot parts of the camera may cause low-temperature burns.
	Do not use this camera as a medical device application. This camera has not been approved as a medical device.
	Keep small parts and cards out of reach of children and infants. There is a risk of accidental ingestion. If you suspect that a camera or any component part has been swallowed, consult a doctor immediately.
	Do not use the camera if lightning starts. Do not touch the camera when lightning starts. Doing so may cause electric shock. It is especially dangerous to use the camera in large open fields during a thunderstorm. Please evacuate to a place where you can avoid lightning strikes as soon as possible.
	Do not disassemble or modify the camera. There are high voltage parts inside, which may cause electric shock if mishandled.

 Caution	
	If carrying the camera into a hospital or onto an aircraft, follow the instructions provided by the hospital and its staff or the airline or airport and its staff. Electromagnetic radiation from the camera may adversely affect the instruments.
	Periodically inspect the camera's installation condition. Failure to do so may cause accidents such as detachment or failure during use.
	Do not use/store the camera in a high temperature area. The inside of a car, including its trunk, especially during summer, can become much hotter than expected (approx. 60°C or more).

	Never leave this camera unattended in an area that may become hot. Doing so may cause a fire, or it may cause deterioration of the camera's outer case, accessories, and/or internal parts.
	Do not use/store the camera in a place where it may be exposed to oily smoke or steam, or excessive moisture or dust. Oil, moisture, and/or dust may conduct electricity, which may cause fire or electric shock.
	Do not leave the lens pointed at the sun or any strong light source. Focused light may damage internal components and cause a fire.
	Do not cover or wrap the camera with cloth or bedding. Doing so may cause heat buildup and deformation of the outer case, which may result in fire.
	Do not apply force to the gimbal. Applying force to the gimbal after turning it on may cause damage to the motors.
	Do not apply load to the gimbal. Doing so may cause the gimbal to malfunction or damage the motors.

## 2. Notice/Cautions for use

- Do not use the camera in an environment where strong electromagnetic waves are radiated, such as around radio towers. Doing so may result in distorted images or noise.
- Do not use this camera in an environment where dew and/or condensation occurs. Water droplets may form on the inside of the camera.
- If the temperature inside the camera rises during use, the power will automatically turn off. If the temperature does not drop, the power will not turn on. Wait for the temperature to cool down before resuming use.
- When cleaning, unplug the power supply/communication connector from the external device and wipe off any dirt with a soft cloth. If the dirt is severe, wipe with a cloth dampened with a mild detergent solution and wring out well, then finish with a dry cloth. The camera is not waterproof, so please handle with care.
- Do not use benzene or thinner for cleaning. They may change the quality of the camera and peel off the paint. When using chemical cleaning agents, please follow the instructions on the label. Do not apply volatile substances such as insecticides to the camera. Also, do not leave rubber and vinyl products in contact for long periods of time. Doing so may cause deterioration or peeling of the paint.
- Use of images taken without the permission of the copyright holder, or the person being photographed

may infringe on the copyright, privacy, or portrait rights of a third party. Please use this camera at your own risk, giving due consideration to the copyrights of third parties and the privacy/portrait rights of the filmed subject.

- When taking important pictures, please make sure that the camera can take pictures normally. In the unlikely event that you are unable to take or record a picture while using this camera due to any of these malfunctions, we assume no responsibility for compensation for the contents of the picture taken or for any losses incurred due to the inability to take or record the picture. In addition, we do not guarantee that images recorded using this camera will be admissible as evidence in a court of law, etc.
- We assume no responsibility for any damage to the human body or property, etc. caused by use of the camera in any manner other than that described in this manual, or for any malfunction or failure of the camera due to use of any non-supplied accessories, or for any damage to the human body or property, etc. caused by such use.
- The specifications in this manual are subject to change without notice. Please be aware of this in advance.

### 3. Troubleshooting

Symptom/Condition	Coping Methods
Power does not turn on.	Check that there are no foreign objects in the power supply/communication connector.
Gimbal does not work	Make sure that no foreign objects are in contact with the camera when initializing the camera position.
No video image	Check that there are no foreign objects in the power supply/communication connector.

### 4. Camera and accessories

Camera

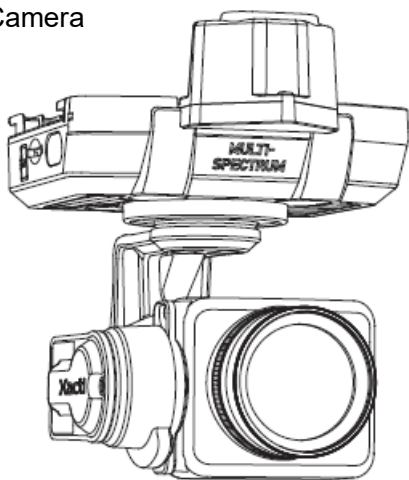

Cap

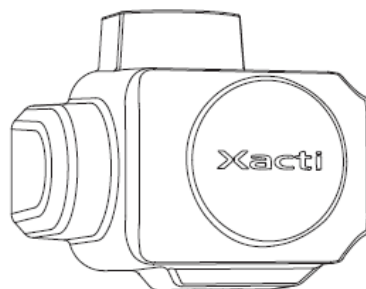

Triple bandpass filter



## 5. Diagram

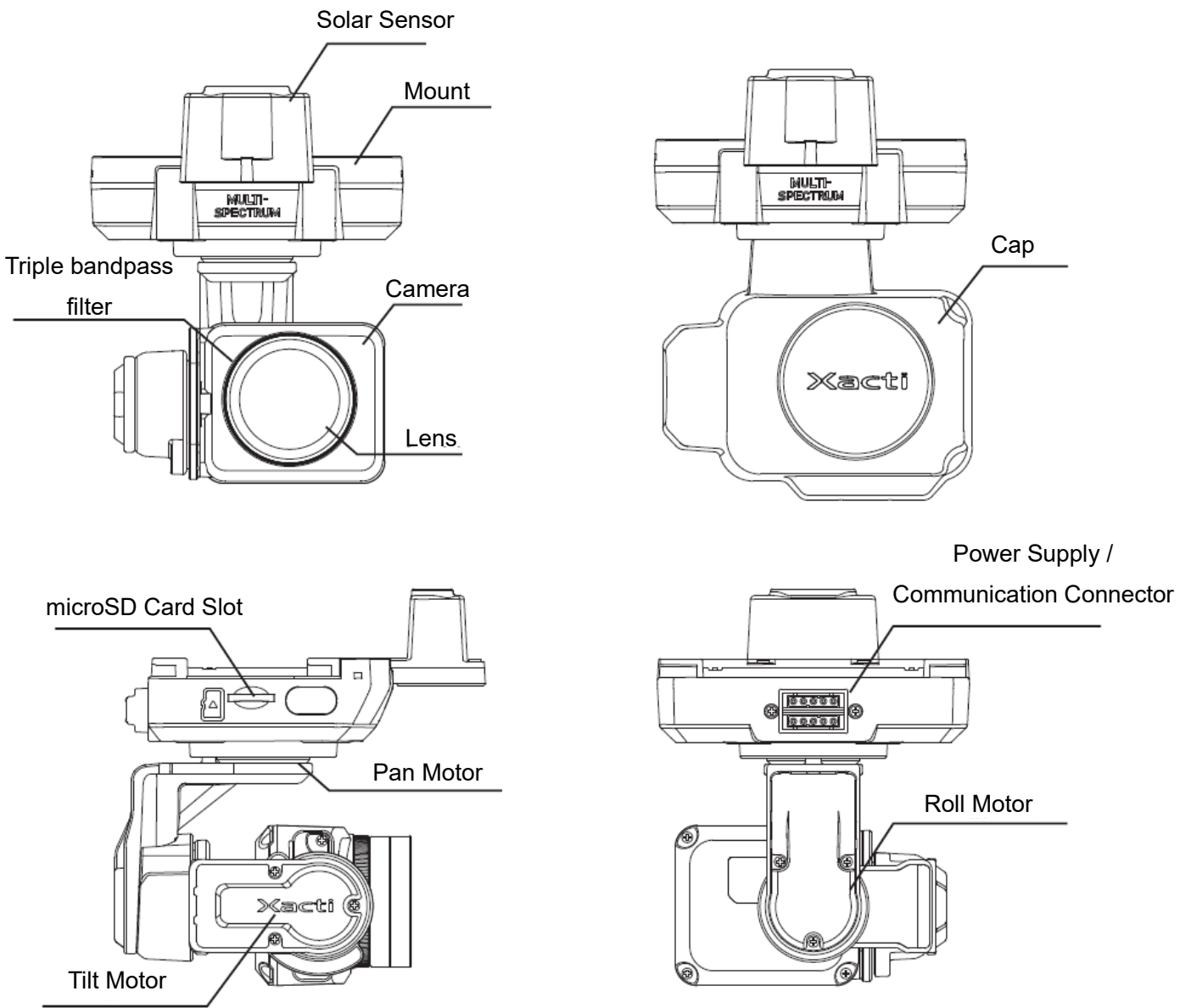

### Cautions

- When not in use, install the cap to prevent damage to the lens and to secure motors.
- DO NOT touch the lens.

## 6. Installing/Removing the cap

### Cautions

- This operation should be performed after disconnecting the camera from the external device.
- When installing or removing the cap to the camera, do not apply force on the motors.

### How to install the cap

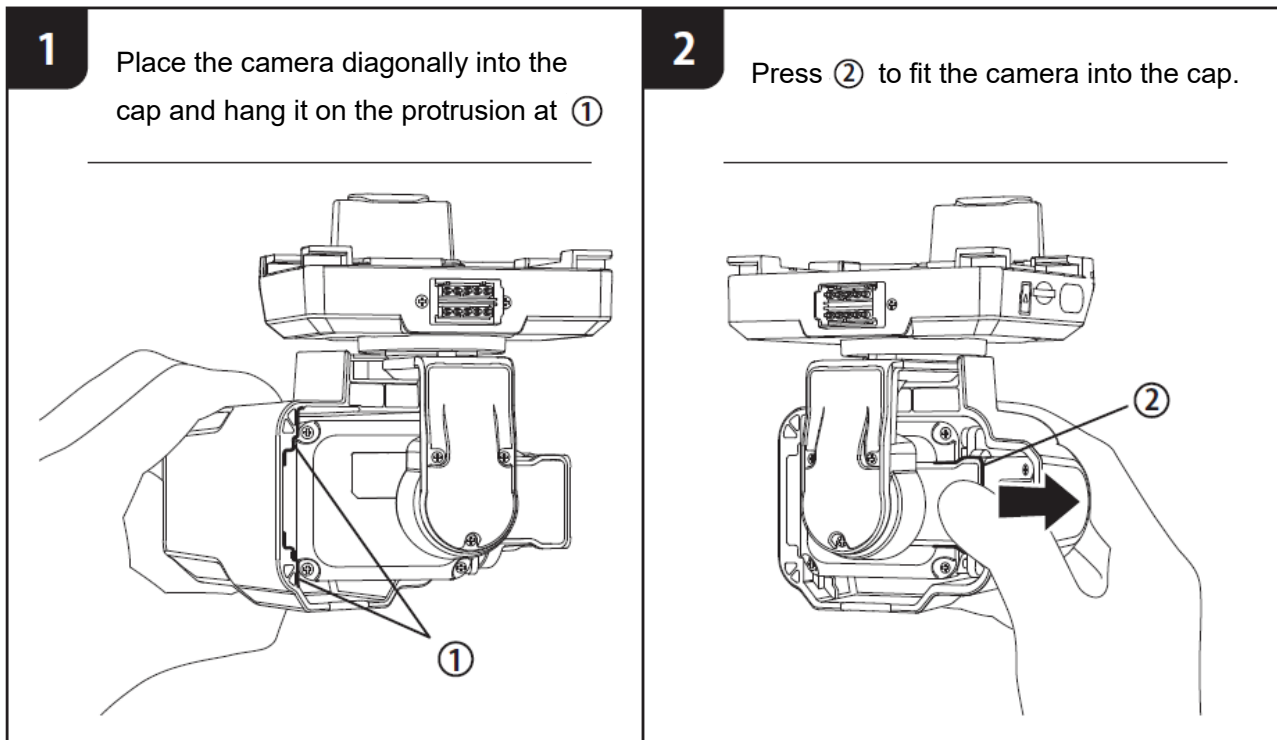

### How to remove the cap

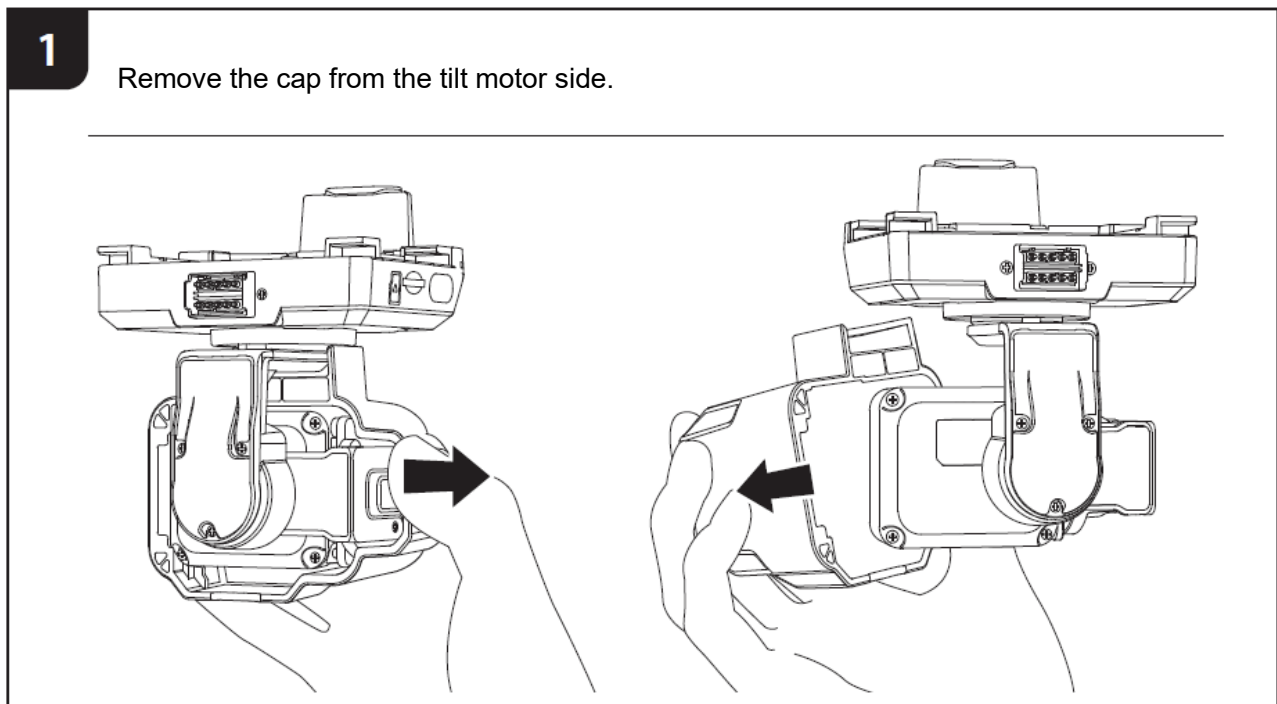



## 7. Installing/Removing the triple bandpass filter

Hold the black frame of the filter and turn it to attach or remove it from the camera.

Make sure the filter is securely attached to prevent accidental detachment during flight.

### Cautions

- DO NOT touch the front and back of the filter.

## 8. Inserting a microSD card

Orient the microSD card correctly as shown, insert the microSD card into the microSD card slot until it "clicks" into place.

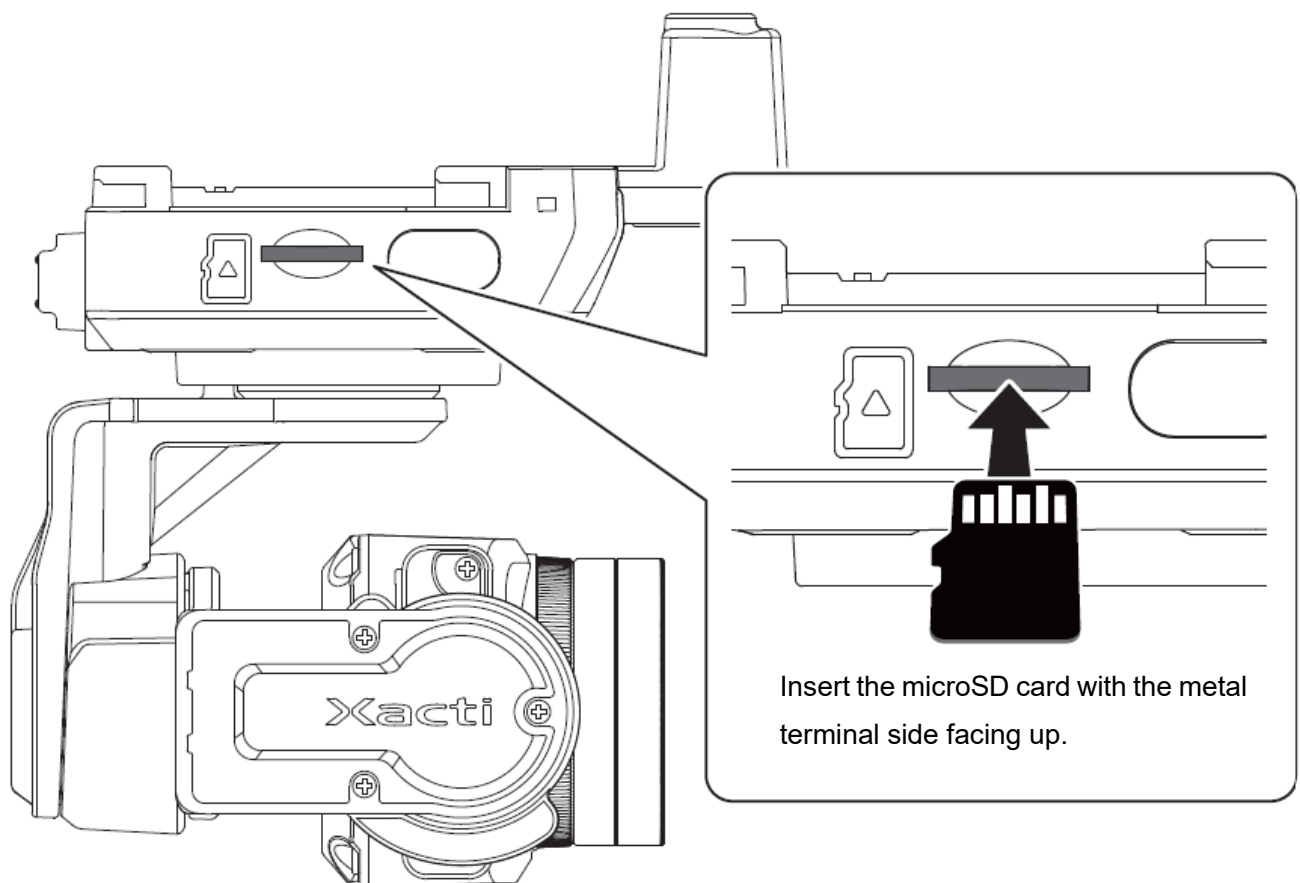

## 9. Specifications

General	
Model name	CX-GB300
Dimensions	Width 78mm × Height 99mm × Depth 93mm
Weight	200g
Dust and waterproof performance	JIS C 0920 IP4X
Supply voltage	12V
Power Consumption	12W (maximum)
Operating Temperature	0° to 40°C
Operating humidity	10 to 90%
Camera	
Image Sensor	Size: 1-inch, Effective Pixels: 20 MP
Lens FOV	H64°, V44°, D73°
Lens Focal Length	35mm format equivalent: 28mm
Aperture Range	F2.8 - F11
Shutter Speed	Mechanical shutter: 8-1/2000 sec. Electronic shutter: 8-1/8000 sec.
ISO Range	AUTO, ISO 125-6400
Still Image Size	TIFF: 2720 x 1814 (5M)
Photo Format	RGB TIFF 16Bit
Live View Format/Quality	MJPEG FullHD / 20p
Supported File Formats	FAT32, exFAT
Supported SD Cards	microSD card (UHS speed class: U3, Video Speed Class V30 or above, maximum capacity: 512GB)
Recommended SD Cards	SanDisk Extreme 32GB (Part Number: SDSQXAF-032G-JN3MD) SanDisk Extreme 64GB (Part Number: SDSQXAF-064G-JN3MD) SanDisk Extreme 128GB (Part Number: SDSQXA0-128G-JN3MD) SanDisk Extreme 256GB (Part Number: SDSQXA0-256G-JN3MD) SanDisk Extreme 512GB (Part Number: SDSQXA1-512G-GN6MN) *Operation is not guaranteed if a card other than the recommended SD card is used.
Gimbal	
Stabilization	3-axis (pan, tilt, roll)
Minimum Control Range	±0.02°
Mechanical Range	Pan: ±90°, Tilt: -120° to +50°, Roll: ±30
Controllable Range	Pan: ±85°, Tilt: -115° to +45
Max Control Speed	Pan: 60°/sec, Tilt/Roll: 100°/sec

Interface	
Communication I/F	USB (UVC / control signal)
Connectors	Pogo pin 10-pole connector

## 10. System specification

This camera receives power supply from an external device and starts up automatically. At startup, the camera position is initialized.

Make sure to turn off the camera from the external device before attaching or detaching this camera.

<p>Cautions</p> <ul style="list-style-type: none"> <li>- Power should be supplied to the camera with no foreign objects in contact with the camera.</li> <li>- If the pan/tilt/roll motors are interfered with during the camera power is on, it may cause the camera to stop working or to malfunction.</li> </ul>
---

## 11. Software information about the camera

This camera contains software licensed under the MIT-License.

See below for license conditions.

The MIT License (MIT)

Copyright (c) 2015 UAVCAN

Permission is hereby granted, free of charge, to any person obtaining a copy of this software and associated documentation files (the "Software"), to deal in the Software without restriction, including without limitation the rights to use, copy, modify, merge, publish, distribute, sublicense, and/or sell copies of the Software, and to permit persons to whom the Software is furnished to do so, subject to the following conditions:

The above copyright notice and this permission notice shall be included in all copies or substantial portions of the Software.

THE SOFTWARE IS PROVIDED "AS IS", WITHOUT WARRANTY OF ANY KIND, EXPRESS OR IMPLIED, INCLUDING BUT NOT LIMITED TO THE WARRANTIES OF MERCHANTABILITY, FITNESS FOR A PARTICULAR PURPOSE AND NONINFRINGEMENT. IN NO EVENT SHALL THE AUTHORS OR COPYRIGHT HOLDERS BE LIABLE FOR ANY CLAIM, DAMAGES OR OTHER LIABILITY, WHETHER IN AN ACTION OF CONTRACT, TORT OR OTHERWISE, ARISING FROM, OUT OF OR IN CONNECTION WITH THE SOFTWARE OR THE USE OR OTHER DEALINGS IN THE SOFTWARE.